



RFID/WAWF/UID Industry-DoD Interface

March 14, 2007
2007 DoD Standardization Program Conference

Rusty Rentsch
Director of Life Cycle Management

Agenda



- Relationship UID – WAWF
- Relationship RFID – WAWF
- Relationship RFID UID
- AIA Activity and resources

UID – WAWF Process

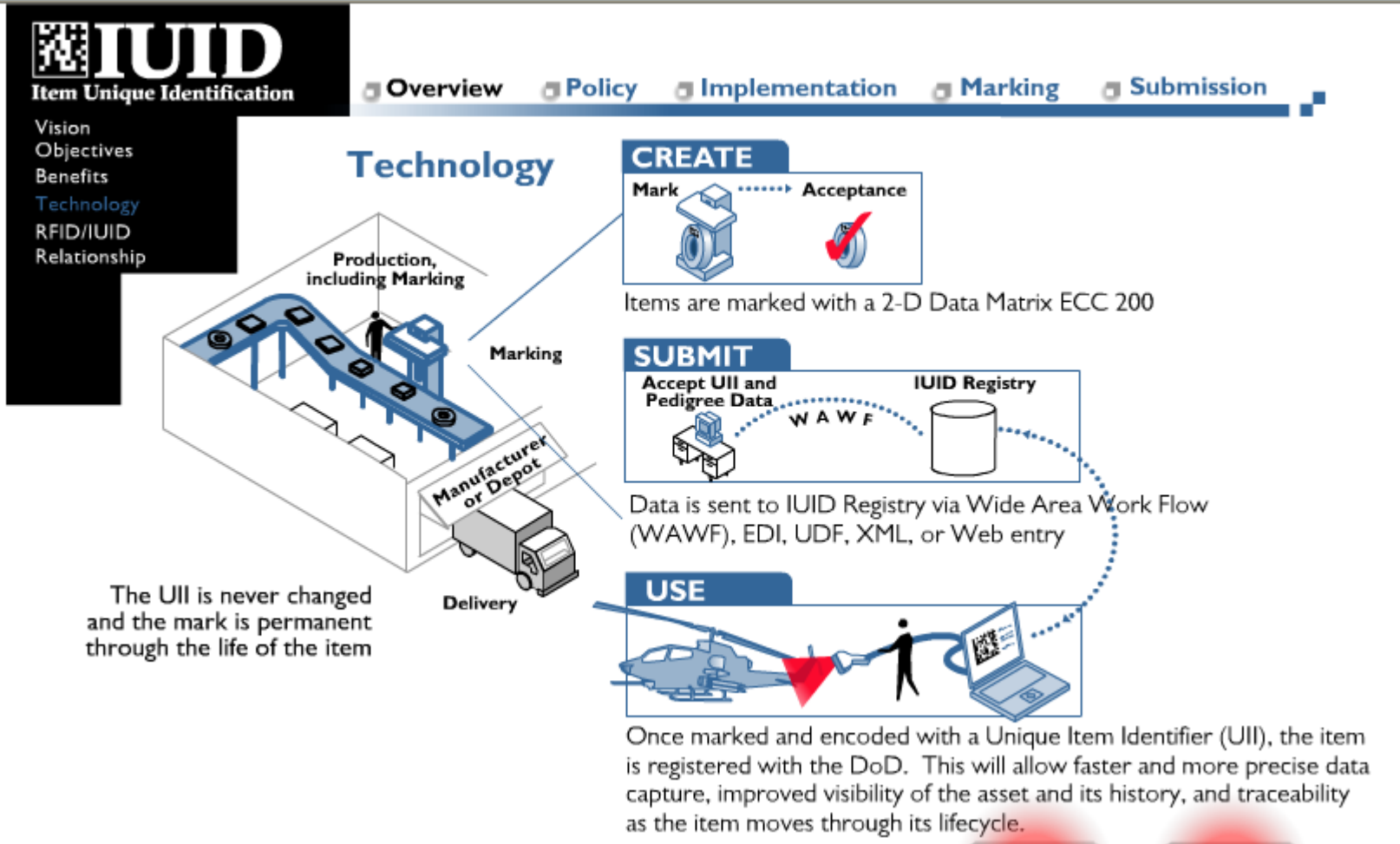

Advance Shipment Notice (ASN)



The current acceptable method for ASN submission is through Wide Area Workflow (WAWF). The RFID mandate requires that all vendors who are contractually obligated to affix passive RFID tags to material must also send an ASN via WAWF. The ASN is not a new process/transaction, but it is the same existing Material Inspection Receiving Report (MIRR) transaction being sent to WAWF with additional data (RFID data elements) added to the transaction. In April 2005, WAWF added the RFID tag ID as an additional data element in the MIRR.

Source: <http://www.acq.osd.mil/log/rfid/index.htm>

WAWF IUID System Integration

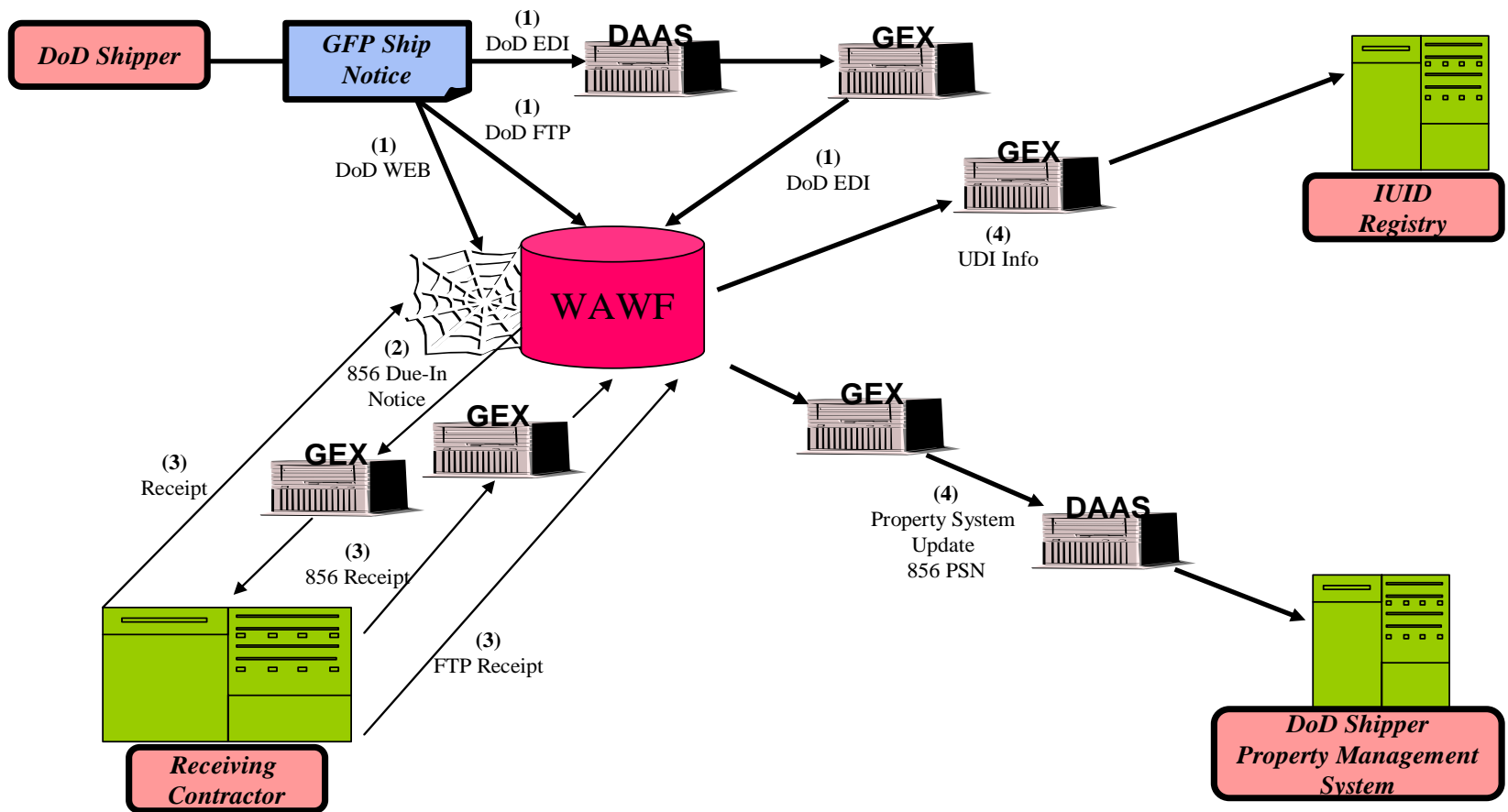

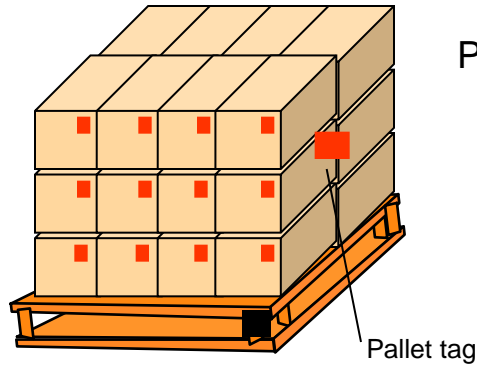

Palletized Unit Load Tag
YES

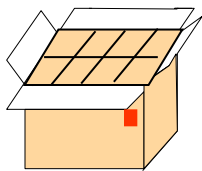

Exterior Container
YES

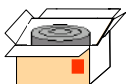

UID Item Unit Pack
YES

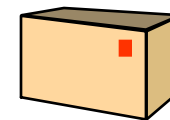
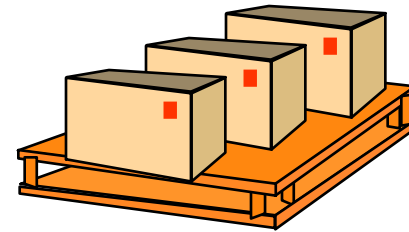

Shipping Container
YES

RFID Best Practices Committee



- AIA member companies chartered the RFID Best Practices Committee
 - Working within the AIA Acquisition Division to develop this common set of best practices for the Aerospace Industry
- Members:
 - Lockheed, MilPac, Raytheon, WFI, Boeing, Northrop Grumman, DCMA, WAWF PM, iMobile

Other AIA Activity and Resources



- AIA Electronic Enterprise Integration Committee
 - “Aerospace Industry Guideline for IUID Data Exchange Between Partner and Prime”
 - “Aerospace Industry Guideline for RFID Data Exchange Between Partner and Prime”
- Resource: AIA Library
 - <http://www.aia-aerospace.org/library/ebusiness/ebusiness.cfm>
- Radio Frequency Identification Aerospace Industry Alignment Team (RAAT)